



Sheer  
Driving Pleasure



# THE NEW BMW X2.

**BMW EFFICIENT DYNAMICS.**  
LESS EMISSIONS. MORE DRIVING PLEASURE.

## THE NEW BMW X2.



## INNOVATION AND TECHNOLOGY.



18 Dynamics and efficiency  
19 Drivetrain and suspension



20 Driver assistance  
21 Safety



22 Connectivity and infotainment  
23 Comfort and functionality

## EQUIPMENT.



24 Package



30 Additional equipment



36 Exterior colours



38 Interior colours

## DIGITAL DISCOVERY: THE NEW BMW BROCHURES APP.



More information, more driving pleasure: The new BMW brochures app offers you a brand new digital and interactive BMW experience. Download the BMW brochures app for your smartphone or tablet now and explore new perspectives of your BMW.



40 Wheels and tyres



41 Original BMW Accessories

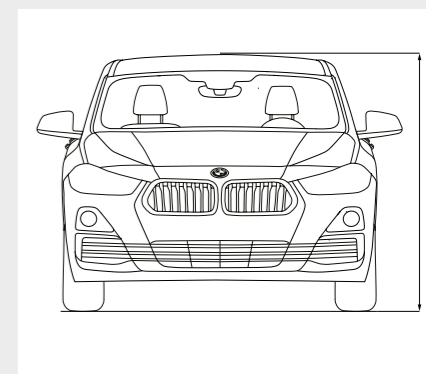

42 Technical data



**I WANT IT ALL.**

**AND MORE.**

*BE THE ONE WHO DARES.*



**I AM EXHILARATION  
AT FIRST GLANCE.**

FOCUSED, FORWARD-THRUSTING FRONT || BRAND NEW,  
REVOLUTIONARY KIDNEY GRILLE DESIGN || LARGE CENTRAL  
AIR INTAKE WITH HEXAGONAL FRAME IN FROZEN GREY\* ||  
FLANKED BY TWO STRIKING, TRIANGULAR AIR INTAKES\*

\* Available as optional equipment.



**I DON'T THINK AFTER,  
I THINK AHEAD.**

BMW CONNECTED DRIVE APPS AND SERVICES\* II  
BMW CONNECTED PERSONAL MOBILITY ASSISTANT\* II  
INTELLIGENT DRIVER ASSISTANCE SYSTEMS, INCLUDING  
DRIVING ASSISTANT PLUS\* II BMW HEAD-UP DISPLAY\*

\* Available as optional equipment.



**YOU'LL LIKE  
WHAT YOU SEE.**

SPORTY SILHOUETTE II HOFMEISTER KINK INTEGRATED IN C-PILLAR II  
EXCLUSIVE BMW EMBLEM POSITION II SQUARED-OFF WHEEL-ARCHES II  
SIDE SKIRTS WITH HEXAGONAL SHAPE IN BODY COLOUR\*

\* Available as optional equipment.



**MY CHALLENGE:  
CHALLENGE CONVENTION.**

HIGH IMPACT THROUGH DISTINCTIVE AND MEMORABLE REAR DESIGN II  
POWERFULLY FORMED M REAR SPOILER\* II LED REAR LIGHTS WITH  
DYNAMIC COMBINATION OF CLASSIC BMW X AND BMW COUPÉ L FORMS

\* Available as optional equipment.



**I START AT THE LIMIT.**

POWERFUL AND EFFICIENT BMW TWIN POWER TURBO ENGINES II  
BMW xDRIVE\* WITH HILL DESCENT CONTROL II M SPORT SUSPENSION\*  
AND M SPORT STEERING\* II IMPRESSIVE TRACTION II OUTSTANDING  
AGILITY II PRECISE HANDLING

\* Available as optional equipment.





**I AM THE NEW BMW X2.**

**REVOLUTIONARY DESIGN, INNOVATIVE TECHNOLOGY AND AN IRRESISTIBLE LIFESTYLE.**

THE NEW BMW X2 GOES NEW WAYS IN EVERY WAY, THRILLS WITH ITS IMPRESSIVE TALENTS AND PROMISES A DRIVING EXPERIENCE THAT, FROM HEAD TO TOE, FROM HEAD-UP DISPLAY\* TO ACCELERATOR PEDAL, OFFERS PURE HAPPINESS. LIFE GETS EVEN MORE EXCITING – **IN THE NEW BMW X2.**

\* Available as optional equipment.

# DYNAMICS AND EFFICIENCY.

**BMW EFFICIENT DYNAMICS.**  
LESS EMISSIONS. MORE DRIVING PLEASURE.

## MORE POWER FROM LESS FUEL.

More power from three to 12 cylinders. Consume less, experience more – the **BMW TwinPower** Turbo engines offer the greatest possible dynamic performance with the highest efficiency thanks to the latest injection systems, variable output control and sophisticated turbocharger technology. Whether diesel or petrol, and no matter how many cylinders, the engines from the BMW EfficientDynamics engine family allow markedly more agile power delivery and outstanding responsiveness even at low rpm, while being fuel-efficient and low in emissions.

## MORE DRIVING PLEASURE, LESS EMISSIONS.

Approximately 33% less CO<sub>2</sub> emissions since 2000: **BMW EfficientDynamics** is a technology package that includes not only the drive, but rather the whole vehicle concept and intelligent energy management. Provided as standard in every BMW, a variety of innovative technologies contribute to continuously improving efficiency. Via engine efficiency measures, electrification, lightweight construction methods and optimised aerodynamics, BMW has managed to reduce the CO<sub>2</sub> emissions of its fleet by 33%.

## MORE SPEED, LESS WEIGHT.

Lower weight with intelligent lightweight construction. Special consideration for every last detail – intelligent lightweight construction means that the optimal material is found and implemented for each part of the vehicle. With extremely light high-tech materials such as aluminium and carbon fibre, **BMW EfficientLightweight** is pursuing the goal of minimising vehicle weight. That leads to even more dynamic performance, increased stability and heightened vehicle safety and comfort.



## AERODYNAMICS.

Targeted aerodynamic changes to the vehicle body such as air vent control, Air Curtain and Air Blades improve its air resistance. The airflow-optimised components contribute not only to reduced fuel consumption, but also reduce the level of noise in the interior.

## DRIVING EXPERIENCE CONTROL INCL. ECO PRO MODE

The Driving Experience Control lets the driver choose between the standard COMFORT mode, ECO PRO Mode which is geared towards efficiency, and SPORT mode which enables even more dynamic driving. ECO PRO mode adjusts the characteristics of the accelerator, Steptronic transmission and the heating/air conditioning settings to make the drive as fuel-efficient as possible.

## INTELLIGENT START/STOP FUNCTION

The Intelligent Start/Stop function<sup>1</sup> enhances driving comfort by switching off the engine only when a specific standing time is expected.

# IN THE NEW BMW X2.

# DRIVETRAIN AND SUSPENSION.

Innovation and Technology 18 | 19



## ENGINE HIGHLIGHTS OF THE NEW BMW X2.

### BMW X2 sDrive20i

BMW TwinPower Turbo four-cylinder petrol engine with TwinScroll turbocharger with 141kW (192hp) and 280Nm of torque  
Acceleration 0–100km/h: 7.7s  
Top speed: 227km/h  
Combined fuel consumption: 5.5–5.9l/100km  
Combined CO<sub>2</sub> emissions: 126–134g/km

### BMW X2 xDrive20d

BMW TwinPower Turbo four-cylinder diesel engine with two-stage turbocharger and variable turbine geometry, NOx storage catalytic converter and SCR system with 140kW (190hp) and 400Nm torque  
Acceleration 0–100km/h: 7.7s  
Top speed: 221km/h  
Combined fuel consumption: 4.6–4.8l/100km  
Combined CO<sub>2</sub> emissions: 121–126g/km

Agility, outstanding steering characteristics and impressive comfort are the hallmarks of the running gear's driving behaviour. The front single-joint trailing-arm axle, compact multi-arm rear axle with separate spring/damper arrangement and high level of body rigidity lay the foundations for this excellence. Its axle kinematics, gas-filled shock absorber and stabilisers are extremely dynamics-oriented.

**Dynamic Damper Control<sup>2</sup>** with a suspension lowering of ten millimetres combines driving dynamics and comfort with a high level of safety. The driver has the option of preselecting the damper characteristics via the Driving Experience Control. Along with the standard COMFORT setting, SPORT mode is also available.

**M Sport suspension<sup>2</sup>** – which includes a chassis which is lowered by 10 millimetres – is characterised by more athletic suspension settings. In addition to shorter bearing springs, it also encompasses tighter damper settings. Together these lead to a lower centre of gravity. This results in even more direct settings, along with reduced body roll, leading to improved agility.

The **M Sports<sup>2</sup>** steering with Servotronic creates a direct and agile steering response and ensures less physical effort is required to turn the wheel. The vehicle can be directed more precisely, offering highly athletic handling characteristics, particularly on winding roads. It also makes steering easier while parking, turning and manoeuvring.

The intelligent BMW **xDrive** all-wheel drive system smoothly and variably distributes drive power to the front and rear wheels for maximum traction, driving dynamics and safety in every driving situation. For even better agility, the electronically controlled power distribution for instance counterbalances oversteer or understeer on bends.

The **8-speed Steptronic Sport<sup>2</sup>** transmission offers incredibly sporty gear changes. Whether automatic or manual using gearshift paddles or gear lever.

The **7-speed Steptronic Sport transmission with double clutch<sup>2</sup>** offers incredibly sporty gear changes, both automatically and manually via the selector lever or gearshift paddles.

<sup>1</sup> Only available in conjunction with navigation system.

<sup>2</sup> Available as optional equipment.

The figures for output, fuel consumption and CO<sub>2</sub> emissions refer to vehicles with a standard transmission.

Fuel consumption and CO<sub>2</sub> emissions are dependent on the selected tyre format (higher figures refer to models with optional wheels).

Further information on fuel consumption and CO<sub>2</sub> emissions can be found in technical data or consult your local BMW partner.

# DRIVER ASSISTANCE.



The **Driving Assistant<sup>1</sup>** safety package draws the driver's attention<sup>2</sup> to an unintentional lane change or possible collision and brakes automatically in the event of an emergency.

The **Driving Assistant Plus<sup>1</sup>** equipment option not only includes systems from the Driving Assistant equipment, which include the Lane Departure Warning, Approach control warning and Person warning with light city braking function<sup>2</sup>, the High-beam assistant and Speed Limit Info<sup>3</sup>, but also additionally includes Camera-based cruise control with Stop&Go function<sup>2</sup> as well as the Traffic jam assistant. The Camera-based cruise control with Stop&Go function maintains your desired speed in a range of 0 to 140 km/h and keeps the distance to the vehicle in front. The Stop&Go function even controls speed down to a standstill, and automatically restarts the vehicle after an interval of up to three seconds. The vehicle accelerates back up to the set speed if the RES button or accelerator are pressed. Traffic jam assistant eases your burden on motorways and in other monotonous traffic situations. At speeds of up to 60 km/h, the system lets the car simply "glide along" with the other cars in dense traffic situations, making traffic jams less stressful. It automatically maintains the desired distance from the vehicle ahead and regulates the car's speed down to standstill, all while providing active steering support – as long as you keep one hand on the steering wheel.

The **Parking assistant<sup>1</sup>** makes parallel parking easier. The system works by measuring potential spaces while driving past them at a low speed. When a suitable space has been found, the Parking Assistant takes over steering, while you are responsible for selecting the correct gear, as well as pressing the accelerator and brake.

The full-colour **BMW Head-Up Display<sup>1,4</sup>** projects information relevant to the journey directly into the driver's field of vision, thereby allowing them to fully concentrate on driving. The display includes information such as the current speed, navigation directions, Speed Limit Info incl. no-overtaking indicator, along with telephone and entertainment lists.

The **extended contents of the instrument cluster<sup>1</sup>** in Black Panel technology include a larger high-resolution TFT display which can show navigation tips, operational messages and various vehicle information such as lists of radio stations, music titles or contact information.

The optional **Hill Descent Control (HDC)** in the xDrive models is a system which, when activated, ensures that the vehicle can master the steepest downhill runs automatically and safely at just above walking pace, without the driver having to brake.

# SAFETY.

■ Standard equipment □ Optional equipment



■ The **Attentiveness assistant** checks the driver's behaviour for signs of fatigue and recommends that the driver take a break if necessary.



□ The **Intelligent Emergency Call** automatically establishes a connection with the nearest rescue coordination centre through the BMW call centre whenever needed – without the use of a mobile phone. It transmits information regarding the vehicle's current location and the severity of the accident. The Intelligent Emergency Call can also be triggered manually in case other road users require help, for example.

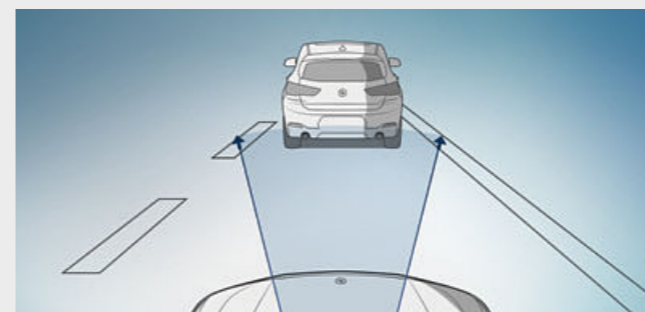

□ **Approach control warning<sup>2</sup>** with light city braking function warns of potentially critical situations to help prevent accidents. If there is a risk of collision with a vehicle moving or standing ahead, it provides a two-stage warning and, if necessary, pre-conditions the brakes for increased responsiveness. In case of an emergency, the system initiates braking, ensuring that the collision speed is significantly reduced.

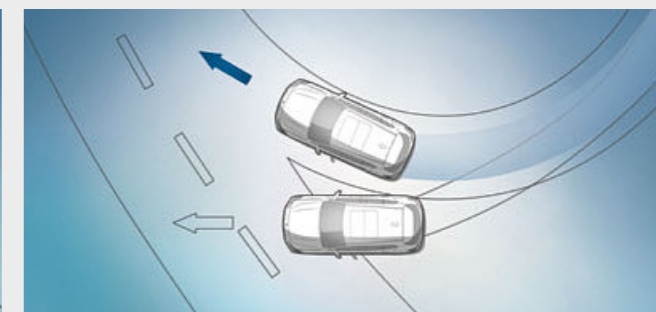

■ **Dynamic Stability Control (DSC)** permanently assesses the vehicle's movements and stabilises it using engine and braking regulation when unstable driving conditions are detected. Additional features of DSC are, for example, brake drying, braking readiness or the Hill-Start assistant, which holds the vehicle briefly in place when starting on inclines to prevent it from rolling backwards.

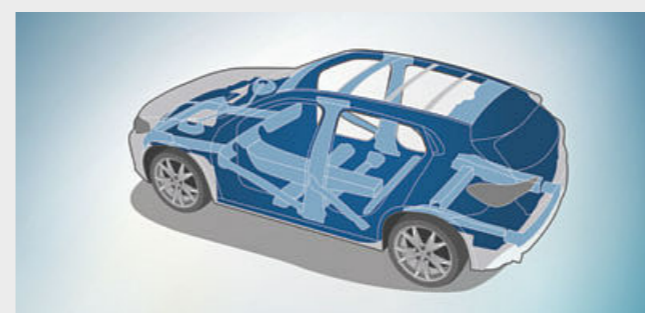

■ The extremely torsionally stiff but light **body construction** provides the basis for sporty driving dynamics, high-precision steering and agility. What is more, it offers passengers perfect all-round protection at all times.

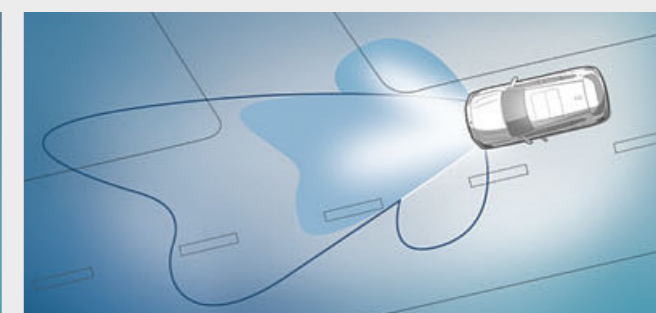

□ The **LED headlights** with extended contents offer a bright and efficient bi-LED light for low and high-beam headlights. The bend lighting and cornering lights with LED technology are also integrated and allow for variable light distribution with increased side illumination for city driving and on country roads.

<sup>1</sup> Available as optional equipment.

<sup>2</sup> Function may be limited in darkness, fog or bright glare.

<sup>3</sup> Only available in conjunction with navigation system.

<sup>4</sup> The information in the BMW Head-Up Display is not fully visible when viewed through polarised sunglasses. The exact content shown will depend on the equipment options chosen. Further optional equipment is required for content to be displayed.

# CONNECTIVITY AND INFOTAINMENT.

## BMW ConnectedDrive Connected to be free.

CONNECTED  
FOR OVER **40** YEARS.

Focused on the future – from the very beginning. By the 1970s, BMW had already made headway in connected mobility. Another milestone of the digital future was surpassed in 1999: vehicles with built-in SIM cards. Then came the first online functionality, Google Services and innovative display systems such as the BMW Head-Up Display. Throughout this process, the desires of the customer have always taken centre stage. In a first for a premium automobile manufacturer, BMW makes it possible to book and pay for services flexibly via the BMW ConnectedDrive Store, in the vehicle or on a computer at home. And with the introduction of BMW Connected and the Open Mobility Cloud, BMW is taking the next steps into the future of mobility.

MORE THAN **20**  
SERVICES AND APPS IN THE  
BMW CONNECTED DRIVE STORE.

The ConnectedDrive Services equipment forms the basis for intelligent BMW ConnectedDrive functions, as well as for the integration of selected smartphone apps. This equipment also provides access to the BMW ConnectedDrive Store, in which services and apps can be ordered and extended easily, any time and anywhere to suit the user's individual requirements – for example with the Concierge Service or Online Entertainment, which turn every drive into a convenient and entertaining experience.

IN TOUCH **24/7** WITH  
BMW CONNECTED.

What would it be like if you were never late again? What if your BMW already knew your preferred destinations? How would you like reliable navigation, whether you're sitting in your vehicle or not? BMW Connected provides you with the information you want, when and where you want it. BMW Connected is a personal mobility assistant which facilitates your everyday mobility and aids you in reaching your destinations relaxed and on time. With the BMW Connected app, mobility-relevant information such as recommendations for optimal departure times are available at any time via smartphone or smartwatch and can be seamlessly transmitted to the car.



### BMW CONNECTED+

BMW Connected+<sup>1,2</sup> provides a more extensive level of integration of the BMW Connected app in your BMW. You can enjoy seamless connectivity between all BMW Connected touchpoints and your BMW and thus benefit from the personalised services supported by the BMW Open Mobility Cloud.

### WiFi HOTSPOT

The equipment includes a built-in WiFi hotspot<sup>1,3</sup> using the LTE standard, which allows for a paid Internet connection. The vehicle is connected via the built-in SIM card with a fee-based hotspot plan from a service provider.

### CONCIERGE SERVICE

Concierge Service<sup>1,2</sup> puts the driver through to a BMW Call Centre employee at the touch of a button. The employee can locate a particular restaurant, the closest cash dispenser or an emergency pharmacy and send the address details directly to the car's BMW navigation system.

## IN THE NEW BMW X2.

<sup>1</sup> Available as optional equipment.

<sup>2</sup> ConnectedDrive Services is required for use.

<sup>3</sup> The WiFi hotspot enables in-vehicle use of the internet with the maximum LTE standard. Use is subject to cost.

Some ConnectedDrive Services may differ between countries. Please consult your local BMW partner for more information.

# COMFORT AND FUNCTIONALITY.



The **Automatic air conditioning**<sup>1</sup> with two-zone control and automatic temperature control features separate controls for the driver and front passenger. It also includes Automatic Air Recirculation (AAR), a micro active carbon filter, a fog and solar sensor, as well as rear air vents.

**Navigation Plus**<sup>1</sup> features a BMW Head-Up Display, an iDrive Touch Controller, a built-in 8.8" touch display and an instrument cluster with high-resolution 5.7" TFT display. The system is operated intuitively using either the iDrive Touch Controller, the direct menu control buttons and eight functional bookmarks, voice control or the touchscreen with interactive tiles.

The driver utilizes BMW „Media“ communications and information system via the central Control Display, the multifunction steering wheel and the BMW iDrive Controller for intuitive operation of the radio, the hands-free facility and the audio streaming functions via Bluetooth or USB port.

The **through-loading** system includes rear seat backrests that can be flexibly divided in a 40:20:40 ratio. For example, two passengers can be seated comfortably in the rear, while long objects such as ski and snowboard bags can be transported at the same time. The centre armrest features two cupholders.

In combination with a special tow ball head, the **Rear-mounted rack preparation**<sup>1</sup> allows the Original BMW Accessories bike rack to be easily mounted. This feature includes a swivelling electrical socket to connect the additional rear lights, and a fixture on the vehicle for mounting the rear bicycle rack.

# BASE.

Discover more with the new BMW catalogue app. Now available for your smartphone and tablet.

■ Standard equipment □ Optional equipment



■ In the new BMW X2, classic BMW driver orientation, the dynamic lines of the surfaces plus contrast and decorative stitching in the instrument panel combine to create an exclusive space focused on the driving experience. The functional control elements are in matt Black and the audio and air conditioning control elements as well as the centre console are finished in high-gloss Black and are shown here in combination with the dark matt Oxide Silver interior trim with high-gloss Black accents.

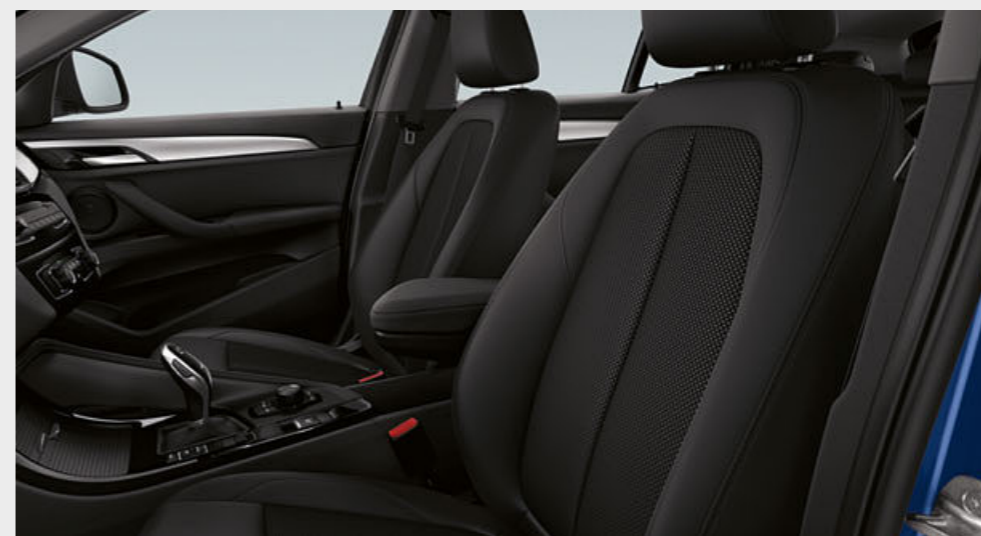

■ The elevated seating position offers a good overview and helps to ensure optimal control while driving. The standard seats, shown here in standard Grid Anthracite cloth, offer optimal hold and comfort thanks to plenty of adjustment possibilities.

## Selected base model equipment features:

- 17" light alloy wheels V-spoke style 560
- Standard seats, front incl. seat length, seat height and backrest tilt adjustment in Grid cloth, other upholstery available
- Air conditioning
- Storage package incl. stainless steel edge trim
- Media with 6.5" Control Display and BMW iDrive Controller, voice control with Bluetooth connectivity incl. audio streaming for compatible smartphones and USB interface
- Free-form halogen headlights with daytime running lights in LED technology, rear lights and brake lights in LED technology
- Fog lights
- Driving Experience Control
- Performance Control
- Servotronic
- Leather steering wheel
- Electronic parking brake
- Rain sensor with automatic headlight activation
- Heated exterior door mirrors and windscreen washer nozzles
- 40/20/40 split-folding rear seats with two locking positions incl. armrest and two cupholders
- Luggage compartment with folding shelf, storage tray with net and strap, 12V sockets in front and rear centre consoles and the luggage compartment

- Six loudspeakers, 100 watts
- Eight bookmarks
- Roller cover for cupholder and front centre console tray
- Instrument panel flap compartment, driver's side
- Instrument cluster with Black Panel technology



■ 17" light alloy wheels V-spoke style 560 in Reflex Silver, wheel size 7.5J x 17 with 225/55 R17 tyres.



□ 19" light alloy wheels Y-spoke style 511 Orbit Grey, gloss-lathed with runflat tyres, wheel size 8J x 19 with 225/45 R19 tyres.

# M SPORT PACKAGE.

Discover more with the new BMW catalogue app. Now available for your smartphone and tablet.

powered by 

■ Standard equipment □ Optional equipment



■ The interior is stretched horizontally by the continuous accent trim and the extensive decorative trims. The M leather steering wheel in the BMW M-specific three-spoke design with rim in Walknappa leather and contoured thumbrests sits particular well in the hands. The sporty look in the interior is further enhanced by the Aluminium Hexagon trim with matt Blue accents.



□ The standard Sport seats in a specific design offer even more comfortable hold thanks to raised seat base and backrest sides as well as additional adjustment possibilities such as seat depth and backrest width. The seats in optional Black Dakota leather with perforations and Blue accents combine perfectly with the interior trims and underscore the sporty ambience.

## M Sport package exterior equipment:

- M Aerodynamics package including front apron with insert in Dark Shadow metallic, specially designed air inlets and side skirts in the body colour with inserts in Dark Shadow metallic, wheel arch trim and claddings in the body colour and rear apron with diffuser insert in Dark Shadow metallic
- 19" M light alloy wheels Double-spoke style 715 M with run-flat properties, alternatively
- 20" M light alloy wheels Double-spoke style 716 M with run-flat properties
- Lowered M Sport suspension, alternatively
- Lowered Dynamic Damper Control or Standard suspension
- BMW Individual high-gloss Shadow Line, alternatively BMW Individual Exterior Line Aluminium satinated
- M designation on the sides
- Exclusive paintwork in Misano Blue metallic; other paintworks available
- M rear spoiler

## M Sport package interior equipment:

- M door sill finishers front, M driver footrest
- Sport seats for driver and front passenger in cloth/Alcantara combination 'Micro Hexagon' in exclusive M look, alternatively in cloth/Alcantara combination 'Micro Hexagon' with yellow accent or
- Leather 'Dakota' with perforations in Black with Blue accent; other upholsteries available
- M Leather steering wheel
- BMW Individual headliner Anthracite
- Interior trim finishers in Aluminium Hexagon with Blue matt accent, alternatively Interior trim finishers in Aluminium Hexagon Anthracite or Aluminium Hexagon with Pearl Chrome accent; other trims available
- Shortened gear lever with M designation<sup>1,2</sup>
- Exclusive LED optical fibre in the door trims
- Car key with exclusive M designation



■ 19" M light alloy wheels Double-spoke style 715 M, Orbit Grey, gloss-lathed with runflat tyres, wheel size 8J x 19 with 225/45 R19 tyres.



□ 20" M light alloy wheels Double-spoke style 716 M, Jet Black, gloss-lathed with runflat tyres, wheel size 8J x 20 with 225/40 R20 tyres.

<sup>1</sup> Only available in conjunction with manual transmission.  
<sup>2</sup> Manual transmission expected to be available from 03/18.

# M SPORT X PACKAGE.

Discover more with the new BMW catalogue app. Now available for your smartphone and tablet.

powered by 

■ Standard equipment □ Optional equipment



■ The distinctive contrast stitching in the instrument panel and centre console is colour-matched to the contrast stitching in the seats and the floor mat piping, emphasising the dynamic driver orientation of the cockpit. The Aluminium Hexagon Anthracite interior trim with Pearl Chrome accent and the M driver footrest as well as the M leather steering wheel with its grippy rim are further sporty details.



■ The standard Sport seats in Micro Hexagon Alcantara Anthracite cloth with Yellow accents are perfectly matched to the optional Galvanic Gold metallic exterior paint finish and, along with other exterior finishes, further underline the sporty interior styling.

## M Sport X package exterior equipment:

- M Sport X exterior package including front apron with insert in Frozen Grey metallic, specially designed air inlets and side skirts in Frozen Grey metallic with inserts in the body colour, wheel arch trim, claddings and rear apron diffuser insert in Frozen Grey metallic
- 19" M light alloy wheels Y-spoke style 722 M with run-flat properties, alternatively
- 20" M light alloy wheels Double-spoke style 717 M with run-flat properties
- Lowered M Sport suspension, alternatively
- Lowered Dynamic Damper Control, or Standard suspension
- BMW Individual high-gloss Shadow Line, alternatively BMW Individual Exterior Line Aluminium satinated
- M designation on the sides
- Exclusive paintwork in Misano Blue metallic; other paintworks available
- M rear spoiler

## M Sport X package interior equipment:

- M door sill finishers front and M driver footrest
- Sport seats for driver and front passenger in cloth/Alcantara combination 'Micro Hexagon' with yellow accent and in exclusive M look, alternatively in cloth/Alcantara combination 'Micro Hexagon' or
- Leather 'Dakota' with perforations in Black with Blue accent; other upholsteries available
- M Leather steering wheel
- BMW Individual headliner Anthracite
- Interior trim finishers Aluminium Hexagon Anthracite, alternatively Interior trim finishers Aluminium Hexagon with Blue matt accent or Aluminium Hexagon with Pearl Chrome accent; other trims available
- Shortened gear lever with M designation<sup>1,2</sup>
- Exclusive LED optical fibre in the door trims
- Car key with exclusive M designation



■ 19" M light alloy wheels Y-spoke style 722 M, Orbit Grey, gloss-lathed with runflat tyres, wheel size 8J x 19 with 225/45 R19 tyres.



□ 20" M light alloy wheels Double-spoke style 717 M, Orbit Grey matt, gloss-lathed with runflat tyres, wheel size 8J x 20 with 225/40 R20 tyres.

<sup>1</sup> Only available in conjunction with manual transmission.  
<sup>2</sup> Manual transmission expected to be available from 03/18.

# ADDITIONAL EQUIPMENT.

Discover more with the new BMW catalogue app. Now available for your smartphone and tablet.

■ Standard equipment □ Optional equipment



- The LED headlights with extended contents offer bi-LED light for low and high-beam headlights as well as LED cornering and bending lights.
- The light generated by the LED fog lights is very similar to daylight and enables the driver to see better and drive more safely in inclement weather.



- The M rear spoiler emphasises the car's athletic silhouette and reduces unwanted lift. By producing downforce on the rear axle, it provides the vehicle with greater driving stability.



- BMW kidney grille with eight slats per side, facings in high-gloss Black and grille frame in high-gloss Chrome.



- When open, the Panorama glass roof provides a great deal of fresh air. Closed, it creates a bright, light-flooded atmosphere in the interior. It opens and closes completely automatically at the push of a button, or remotely, and is equipped with slide and lift functions, a roller sunblind and wind deflector.



- The front headlights with halogen free-form technology feature integrated daytime driving lights with LED technology and manual light range regulation.



- The two-part rear lights, including tail light and braking light with LED technology, are equipped with a dynamic brake light function.



- The Sun protection glazing for the rear window and tinted rear side windows reduces unwanted warming of the interior.



- The wing mirror caps are painted in high-gloss Black instead of the body colour. They emphasise the car's athletic look and create an individual appearance.



- The premium-quality BMW Individual roof rails high-gloss Shadow Line is the key to a multifunctional BMW roof rack unit.



- The Roof rails in Aluminium satinated provide the base for a multifunctional BMW roof rack unit.



- The Comfort access system<sup>1</sup> allows passengers to enter the car via the front doors and to open the tailgate without having to actively use the key.

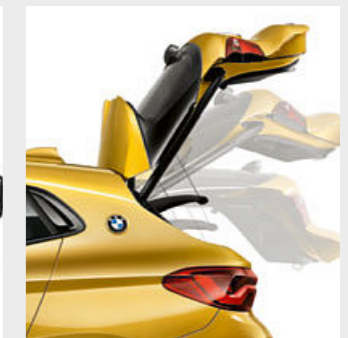

- The Automatic tailgate operation opens and closes the tailgate electrically. Simply press a button.



- BMW Individual high-gloss Shadow Line features numerous equipment and design details in Black high-gloss to boost the vehicle's athletic and elegant character. These include the side window frame surrounds, the window recess finishers, the B-pillar trim, as well as details on the C-pillars and the exterior mirrors.



- The BMW Individual Exterior Line features elegant accents, with trim strips for the side window frames, window recess finishers, and surrounds on the C-pillars in satinated Aluminium. Along with the roof mouldings in body colour, the exterior mirror frames, bases and triangles and the trim on the B-pillars are in a stylish contrasting Black high-gloss.



- Two easily visible, single-flow, round tailpipes with a diameter of 90 millimetres are located on each side at the rear. The tailpipe trim is Chrome high-gloss.



- The Headlight washer system automatically cleans the headlights when the front windscreen washing function is activated and the headlights are on.

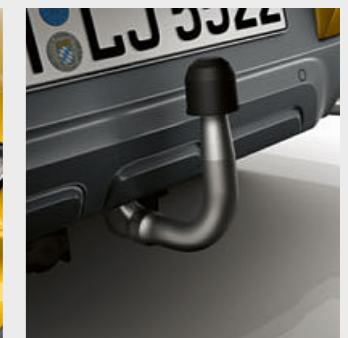

- When not in use, the removable ball head of the trailer tow hitch has no negative impact on the sporty appearance of the rear.

<sup>1</sup> Contactless opening and closing of the tailgate only in combination with Automatic tailgate operation.



# ADDITIONAL EQUIPMENT.

Discover more with the new BMW catalogue app. Now available for your smartphone and tablet.

■ Standard equipment □ Optional equipment



■ Contrast stitching in the centre console and the instrument panel in all upholstery variants. The contrast and decorative stitching are each perfectly colour-matched to the interior.



□ The sport seats have high seat and backrest bolsters, providing optimal support for the driver and front passenger even during athletic driving on bends. In contrast to the standard seats, their seat angle, seat depth, armrest width and thigh rests can be individually adjusted. Their special design highlights the vehicle's athletic capabilities.



□ The atmospheric Lights package contains various LED lights and yields an ambience of pure quality. The driver is welcomed with an impressive welcome-illumination with exterior LEDs. Ambient light atmospherically lights up the interior with a stylish combination of direct and indirect lights.



■ The Storage compartment package offers additional storage options in the interior and luggage compartment. It includes a rear centre armrest with two cupholders, a storage compartment with net on the right side of the luggage compartment and nets on the front seat backrests. 12V power sockets in the rear centre console and in the luggage compartment provide more options for connecting various electronic devices.



□ M Leather steering wheel including multifunction buttons, steering wheel rim in leather 'Walknappa' Black with contoured thumb rests.



□ The black Sport leather steering wheel with a thick rim and contoured thumb rests has an exceptionally pleasant, high-grip feel.



□ The Seat heating for driver and front passenger allows for heating of the entire seat base and backrest.



□ The electrical seat adjustment allows preferred settings for the seat and the exterior mirrors to be saved using the memory function.



□ The Harman Kardon surround sound system, with twelve speakers optimally designed to suit the interior's sound characteristics, guarantees an exceptional music experience. Tweeters and subwoofers deliver a brilliant, powerful range of sound. Elegant aluminium loudspeaker fronts feature „Harman/Kardon“ lettering for a high-class look.



□ The HiFi loudspeaker system with 205 watts amplifier output and seven speakers evenly distributes the sound in the interior of the car.



□ Automatic air conditioning with two-zone control includes Automatic Air Recirculation (AAR) with a micro active carbon filter, as well as fogging and solar sensors.



□ The BMW Individual headliner anthracite with black-lined components gives the interior an athletic flair.



□ The 8-speed Steptronic Sport transmission offers incredibly sporty gear changes. Whether automatic or manual using gearshift paddles or gear lever.



□ The lumbar support for the driver and front passenger seats can be adjusted both vertically and laterally, allowing for an orthopaedically optimised seating position.



■ The through-loading system includes rear seat backrests that can be flexibly divided in a 40:20:40 ratio.

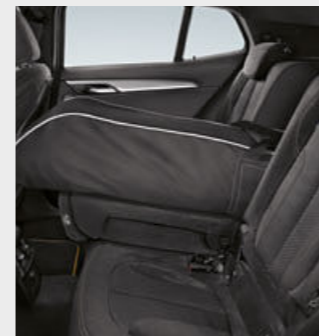

□ The Ski and snowboard bag makes it possible to transport skis or snowboards cleanly and safely.

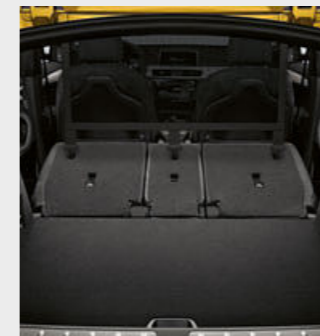

□ The Luggage-compartment separating net can be attached behind the rear or front seats to prevent objects from falling forwards into the passenger area.



■ Various storage options increase the level of comfort and ensure that the interior remains tidy.



□ Interior and driver-side exterior mirrors with automatic anti-dazzle function, including electric fold-in function for the exterior mirrors and automatic curb parking function for the front passenger exterior mirror.

# ADDITIONAL EQUIPMENT.

Discover more with the new BMW catalogue app. Now available for your smartphone and tablet.

■ Standard equipment □ Optional equipment



□ Navigation Plus<sup>1</sup> features a BMW Head-Up Display, an iDrive Touch Controller, a built-in 8.8" touch display and an instrument cluster with high-resolution 5.7" TFT display. The system is operated intuitively using either the iDrive Touch Controller, the direct menu control buttons and eight functional bookmarks, voice control or the touchscreen with interactive tiles.

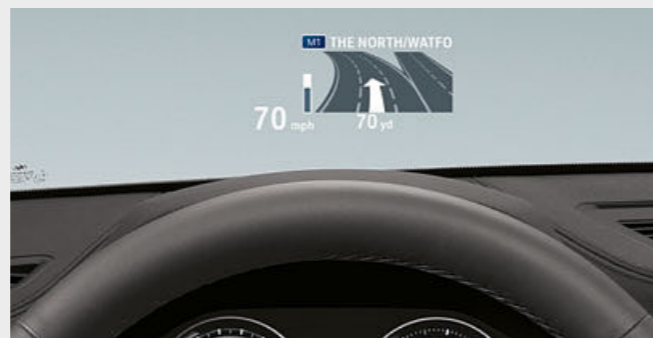

□ The full-colour BMW Head-Up Display<sup>2</sup> projects information relevant to the journey directly into the driver's field of vision, thereby allowing them to fully concentrate on driving. The display includes information such as the current speed, navigation directions, Speed Limit Info incl. no-overtaking indicator, along with telephone and entertainment lists.

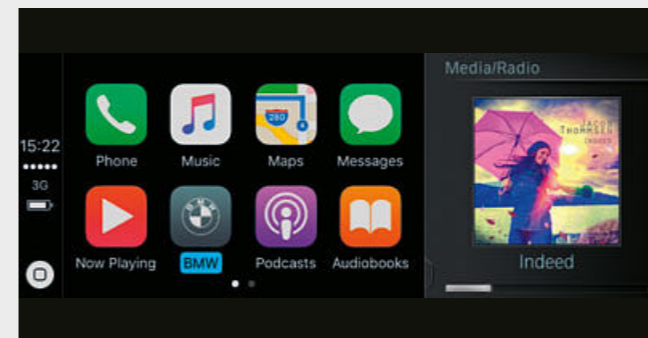

□ Preparation for Apple CarPlay<sup>6, 7, 9</sup> supports the convenient and wireless use of selected iPhone<sup>®</sup> functions in the vehicle. This allows smartphone content and functions such as music, iMessages/text messages, telephony, Siri, navigation and selected third-party apps to be displayed and operated via the vehicle's user interface and via Voice control.



□ The "Share live trip status"<sup>7</sup> function allows you to securely share your time of arrival and current location with friends and family during a trip. The recipient receives a link to a website that displays the destination and current location of the vehicle on a map.



■ The radio, telephone and audio streaming functions can all be used with the „Media“ communications and information system.



□ Telephony with wireless charging offers a comprehensive telephony package with Bluetooth connectivity and the technical capacity for a WiFi hotspot<sup>3</sup>.



□ The extended contents of the instrument cluster<sup>4</sup> in Black Panel technology include a larger high-resolution TFT display which can show navigation tips, operational messages and various vehicle information such as lists of radio stations, music titles or contact information.



□ The Driving Assistant<sup>8</sup> safety package draws the driver's attention to an unintentional lane change or possible collision and brakes automatically in the event of an emergency.

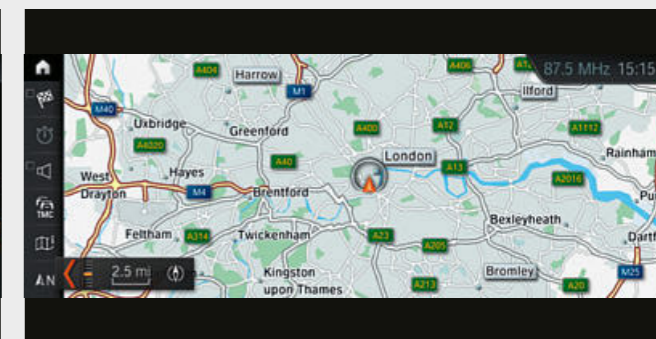

□ Real Time Traffic Information<sup>7, 9</sup> almost instantly delivers traffic information about motorways, country roads and main roads, as well as numerous urban routes.

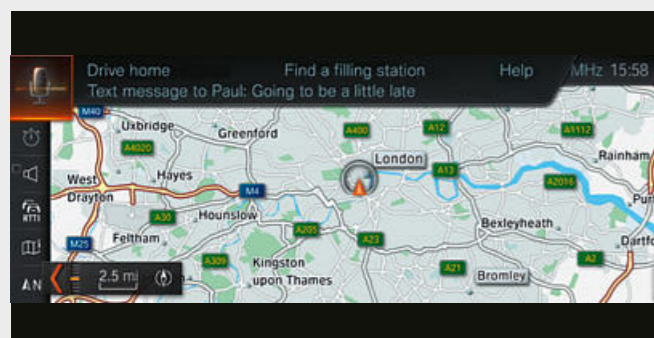

□ Intelligent Voice Assistant<sup>4</sup> understands natural speech and optimises recognition rate over a large range of individual and situational variations thanks to Offboard voice processing<sup>5</sup>. It also understands linguistic varieties, dialects and jargon. This enables a substantially greater range of possibilities when dictating text messages or emails.

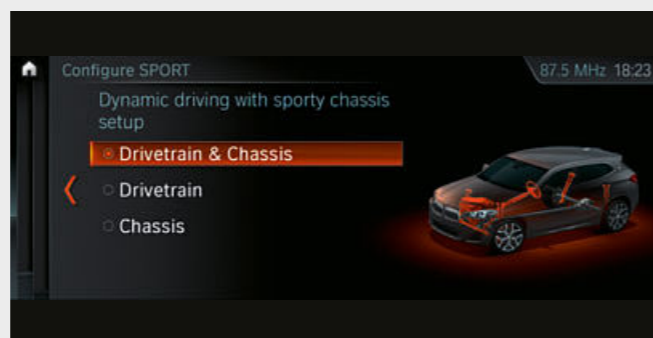

□ The adaptive suspension with a lowering of ten millimetres makes it possible to adjust the damper characteristics to suit the driving situation and combines ride comfort and driving dynamics with the best possible safety. Via the Driving Experience Control, the driver can choose the standard COMFORT mode or the SPORT mode.

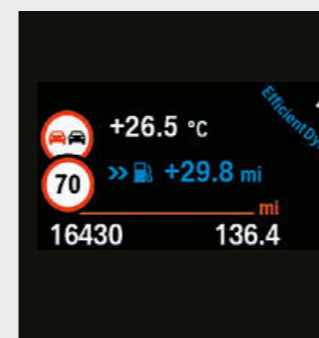

□ The intelligent Speed Limit Info<sup>10</sup> system detects speed limits using a camera and compares the information with navigation system data to establish currently applicable restrictions.



□ The Driving Assistant Plus<sup>8</sup> offers warning and collision safeguard functions, camera-based cruise control and the Traffic jam assistant.

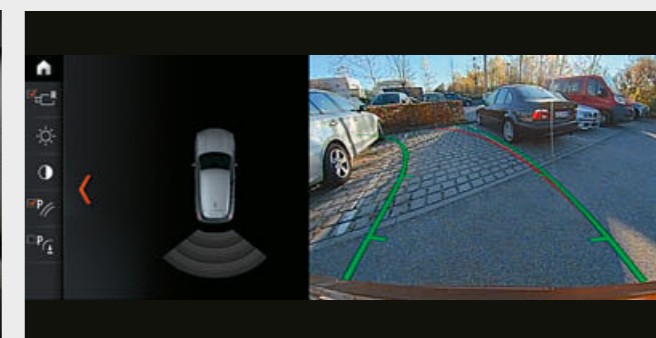

□ The Rear view camera enables improved orientation when reversing at speeds below 15 km/h, for example when parking. It shows the area behind the car on the Control Display. Interactive track lines for measuring distance and turning circles assist you when manoeuvring. Obstacles are marked in colour.

<sup>1</sup> As part of BMW ConnectedDrive, in selected European countries, the system automatically updates maps for three years up to four times per year.  
<sup>2</sup> The information in the BMW Head-Up Display is not fully visible when viewed through polarised sunglasses. The exact content shown will depend on the equipment options chosen. Further optional equipment is required for content to be displayed.

<sup>3</sup> Supports inductive charging for Qi-compatible mobile phones. Special charging cases are available from Original BMW Accessories for selected smartphones that do not support the Qi standard for inductive charging. The WiFi hotspot fulfils all in-vehicle requirements for use of the internet with the maximum LTE standard. Usage is subject to cost.  
<sup>4</sup> Part of the BMW navigation system.

<sup>5</sup> Off-board speech recognition, as a functional extension, can be booked in the ConnectedDrive Store.

<sup>6</sup> Apple CarPlay<sup>®</sup> compatibility and supported functions depend on the model year and the software installed on the iPhone<sup>®</sup>. When the Apple CarPlay<sup>®</sup> preparation is in use, selected vehicle data is transferred to the phone. The mobile phone manufacturer is responsible for any further processing of the data.

<sup>7</sup> Only available in conjunction with ConnectedDrive Services.

<sup>8</sup> Function may be limited in darkness, fog or bright glare.

<sup>9</sup> Only available in conjunction with navigation system.

<sup>10</sup> Part of Driving Assistant and Driving Assistant Plus in conjunction with a BMW navigation system.

# EXTERIOR COLOURS.

Discover more with the new BMW catalogue app. Now available for your smartphone and tablet.

■ Standard equipment □ Optional equipment

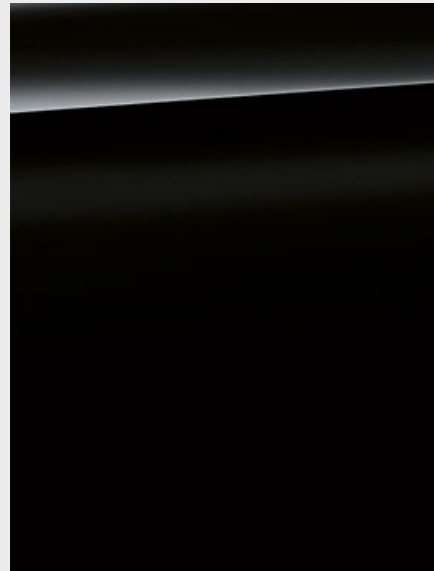

■ **Non-metallic** 668 Black



□ **Non-metallic** 300 Alpine White<sup>1</sup>



□ **Metallic** 475 Black Sapphire<sup>2</sup>



□ **Metallic** A96 Mineral White



□ **Metallic** A83 Glacier Silver

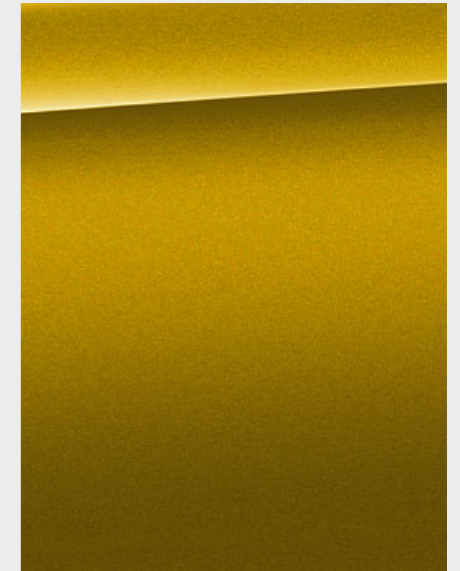

□ **Metallic** WC1P Galvanic Gold<sup>2</sup>

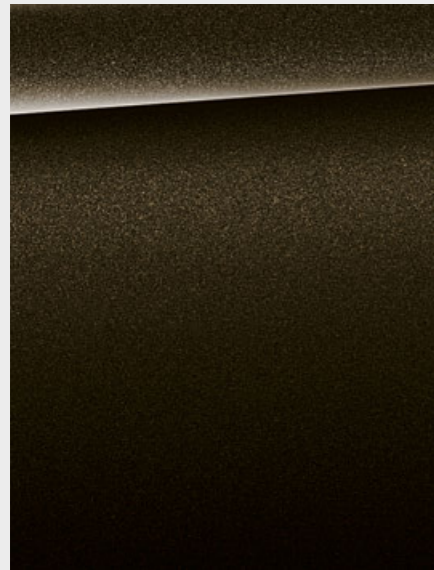

□ **Metallic** C07 Sparkling Storm Brilliant Effect<sup>3</sup>



□ **Metallic** C10 Mediterranean Blue<sup>3</sup>



□ **Metallic** B39 Mineral Grey<sup>2</sup>

## M SPORT PACKAGE M SPORT X PACKAGE

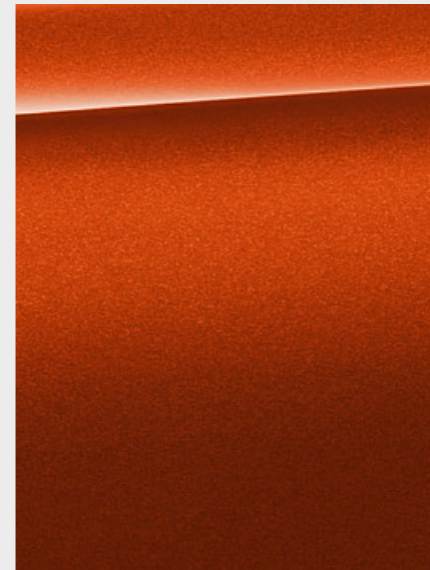

□ **Metallic** C1X Sunset Orange<sup>2</sup>



□ **Metallic** WC1D Misano Blue<sup>4</sup>

**[Colour samples]** These colour samples are intended as an initial guide to the colours and materials available for your BMW. However, experience has shown that printed versions of paint, upholstery and interior trim colours cannot in all cases faithfully reproduce the

appearance of the original colour. Please discuss your preferred colour choices with your BMW partner or dealership. There you can also see original samples and be assisted with special requests.

<sup>1</sup> Available as standard for M Sport package and M Sport X package.  
<sup>2</sup> Also optionally available for M Sport package and M Sport X package.

<sup>3</sup> Also optionally available for M Sport X package.

<sup>4</sup> Exclusively available in conjunction with M Sport package or M Sport X package.

# INTERIOR COLOURS.

Discover more with the new BMW catalogue app. Now available for your smartphone and tablet.

■ Standard equipment □ Optional equipment

## CLOTH

Available with



■ Base

**Grid cloth**  
EGAT Anthracite<sup>1</sup>



□ Base

**Race cloth**  
ERL1 Anthracite,  
Grey accent<sup>2</sup>

## LEATHER

Available with



□ Base  
□ M Sport package  
□ M Sport X package

**Dakota leather**  
PDSW with Black perforations, Grey accent



□ Base  
□ M Sport package  
□ M Sport X package

**Dakota leather**  
PDMZ with Mocha perforations, Walnut accent



□ Base  
□ M Sport package  
□ M Sport X package

**Dakota leather**  
PDOA with Oyster perforations, Grey accent

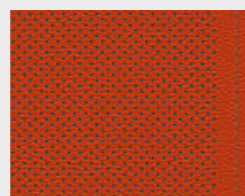

□ Base  
□ M Sport package  
□ M Sport X package

**Dakota leather**  
with Magma Red perforations, Grey accent<sup>2</sup>

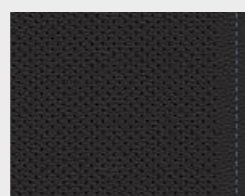

□ M Sport package  
□ M Sport X package

**Dakota leather**  
PDN4 with Black perforations, Blue accent<sup>2</sup>

## INTERIOR TRIMS

Available with



■ Base

4FS Oxide Silver dark matt, highlight trim finisher Black high-gloss.



□ M Sport package  
■ M Sport X package

4WP Aluminium Hexagon Anthracite, Pearl-Gloss Chrome accent line<sup>3</sup>



□ Base  
□ M Sport package  
□ M Sport X package

4F7 Fine-wood trim oak grain matt, highlight trim finisher Pearl Chrome<sup>3</sup>

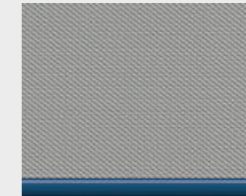

■ M Sport package  
□ M Sport X package

4WF Aluminium Hexagon with matt Blue accent line<sup>3</sup>



□ Base  
□ M Sport package  
□ M Sport X package

4LR Fine-wood trim Fineline Stream, highlight trim finishers Pearl Chrome<sup>3</sup>



■ M Sport package  
■ M Sport X package

4WE Aluminium Hexagon, Pearl-Gloss Chrome accent line<sup>3</sup>



□ Base  
■ M Sport package  
■ M Sport X package

4LS Aluminium, finely brushed lengthwise, highlight trim finishers Pearl Chrome<sup>3</sup>

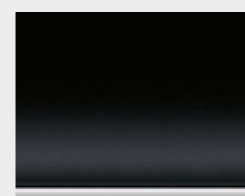

□ Base  
■ M Sport package  
■ M Sport X package

4LU Black high-gloss with Pearl Chrome highlights

## CLOTH-ALCANTARA COMBINATION

Available with

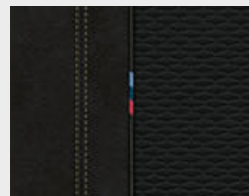

□ M Sport package  
■ M Sport X package

**Micro Hexagon cloth-Alcantara combination**  
HIML Anthracite, Yellow accent<sup>2</sup>

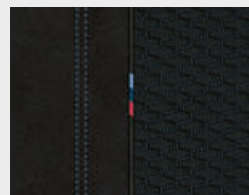

■ M Sport package  
□ M Sport X package

**Micro Hexagon cloth-Alcantara combination**  
HMAT Anthracite, Blue accent<sup>2</sup>

## SENSATEC

Available with

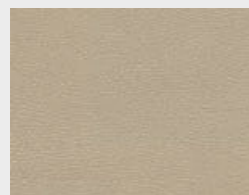

□ Base  
■ M Sport package  
■ M Sport X package

**Sensatec**  
KCCX Oyster

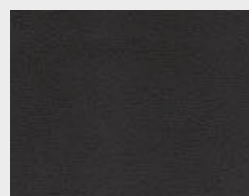

□ Base  
■ M Sport package  
■ M Sport X package

**Sensatec**  
KCSW Black

Please note that even normal long or short-term use can lead to permanent upholstery damage. This can be caused in particular by non-colourfast clothing.

All interior trims apart from 4FS feature an LED light guide in the door trim. The interior colour is dependent on the chosen upholstery colour.

<sup>1</sup> Only available in conjunction with standard seats.

<sup>2</sup> Only available in conjunction with Sport seats.

<sup>3</sup> Additional accent also in the door trim.

# WHEELS AND TYRES.

Discover more with the new BMW catalogue app. Now available for your smartphone and tablet.



■ 17" light alloy wheels V-spoke style 560 in Reflex Silver, wheel size 7.5J x 17 with 225/55 R17 tyres.



□ 17" light alloy wheels Double-spoke style 564 Reflex Silver, wheel size 7.5J x 17 with 225/55 R17 tyres.



□ 17" light alloy wheels turbine styling 561, BMW EfficientDynamics, Orbit Grey, gloss-lathed, wheel size 7.5J x 17, 225/55 R17 tyres.



□ 18" light alloy wheels Double-spoke style 567 Reflex Silver, wheel size 7.5J x 18 with 225/50 R18 tyres.



□ 18" light alloy wheels Y-spoke style 569, Orbit Grey, gloss-lathed, wheel size 7.5J x 18 with 225/50 R18 tyres.



□ 18" light alloy wheels Y-spoke style 566, Ferric Grey, gloss-lathed, wheel size 7.5J x 18 with 225/50 R18 tyres.



□ 19" light alloy wheels Y-spoke style 511 Orbit Grey, gloss-lathed with runflat tyres, wheel size 8J x 19 with 225/45 R19 tyres.



□ 19" M light alloy wheels Y-spoke<sup>1</sup> style 722 M, Orbit Grey, gloss-lathed with runflat tyres, wheel size 8J x 19 with 225/45 R19 tyres.



□ 19" M light alloy wheels Double-spoke<sup>2</sup> style 715 M, Orbit Grey, gloss-lathed with runflat tyres, wheel size 8J x 19 with 225/45 R19 tyres.



□ 20" M light alloy wheels Double-spoke<sup>1</sup> style 717 M, Orbit Grey matt, gloss-lathed with runflat tyres, wheel size 8J x 20 with 225/40 R20 tyres.



□ 20" M light alloy wheels Double-spoke<sup>2</sup> style 716 M, Jet Black, gloss-lathed with runflat tyres, wheel size 8J x 20 with 225/40 R20 tyres.



○ High-quality 19" light alloy wheels V-spoke style 573 in Bicolor black gloss-lathed. Summer complete wheel set with run-flat tyres.

# ORIGINAL BMW ACCESSORIES.

■ Standard equipment □ Optional equipment ○ Accessories



○ The foldable rear bike rack compact is light, yet stable and has a maximum load capacity of up to 60 kg. It can be quickly and securely attached to the tow ball and can accommodate two bicycles/e-bikes. Once folded can be stored in the luggage compartment tray safe from spray and crash-safe.



○ The modern roof box in black with titanium silver side panels has a capacity of 420 litres and is compatible with all BMW roof rack systems. Due to the fact that it can be opened from both sides and has triple central locking on each side it is convenient to load and lock for theft protection.



○ In the event of disturbances, the highly sensitive full-HD camera automatically records the situation around the car.



○ Secure base for the Apple iPad® 2, 3 or 4. The holder is snapped into the basic carrier and can be rotated 360° as well as tilted to the desired angle.



○ The high-quality 18" alloy wheels Y-spoke style 566 are designed in black and lend the vehicle a very sporty appearance. TPMS summer complete wheel with run-flat tyre, wheel size 7.5J x 18 with tyre size 225/50 R18 95W RSC.



○ The durable, anti-slip, water-resistant fitted mat with raised borders on all sides and a shapely design protects the luggage compartment from dirt and moisture. Finished in black with a black X2 inlay it perfectly complements the interior.

<sup>1</sup> Only available in conjunction with M Sport X package. May not be available in all countries, please consult your local BMW partner for further information.

<sup>2</sup> Only available in conjunction with M Sport package.

Discover the wide range of innovative solutions available for the exterior and interior, communication & information, and for transportation & the luggage compartment. Your BMW Partner is on hand to advise you on the whole range of Original BMW Accessories

and can also provide you with a special accessories catalogue. For further information, please visit [www.bmw.com/accessories](http://www.bmw.com/accessories)

BMW X2		sDrive20i	xDrive20d	xDrive25d
<b>Weight</b>				
Unladen EU <sup>1</sup>	kg	1535	1675	1660
Max. permissible	kg	2055	2190	2180
Permitted load	kg	595	590	595
Permitted trailer load, unbraked <sup>2</sup>	kg	750	750	750
Permitted trailer load, braked, max. 12% gradient/max. 8% gradient <sup>2</sup>	kg	1800/1800	2000/2000	2000/2000
Luggage compartment capacity	l	470–1355	470–1355	470–1355
<b>Engine</b>				
Cylinders/valves		4/4	4/4	4/4
Capacity	cc	1998	1995	1995
Rated output/rated engine speed	kW (hp)/rpm	141 (192)/5000–6000	140 (190)/4000	170 (231)/4400
Max. torque/engine speed	Nm/rpm	280/1350–4600	400/1750–2500	450/1500–3000
<b>Power transmission</b>				
Drive configuration		Front-wheel	All-wheel	All-wheel
Standard transmission		Seven-speed DCT	Eight-speed Steptronic	Eight-speed Steptronic
<b>Performance<sup>3</sup></b>				
Top speed	km/h	227	221	237
Acceleration 0–100 km/h	s	7.7	7.7	6.7
<b>Fuel consumption<sup>3,4</sup></b>				
Urban	l/100 km	6.8–7.2	5.2–5.4	5.7–5.9
Extra-urban	l/100 km	4.8–5.1	4.3–4.5	4.7–4.9
Combined	l/100 km	5.5–5.9	4.6–4.8	5.1–5.3
CO <sub>2</sub> emissions, combined	g/km	126–134	121–126	133–139
Tank capacity (approx.)	l	51	51	51
<b>Wheels</b>				
Tyre dimensions		225/55 R17 97 W	225/55 R17 97 W	225/55 R17 97 W
Wheel dimensions		7.5 J x 17	7.5 J x 17	7.5 J x 17
Material		Light alloy	Light alloy	Light alloy

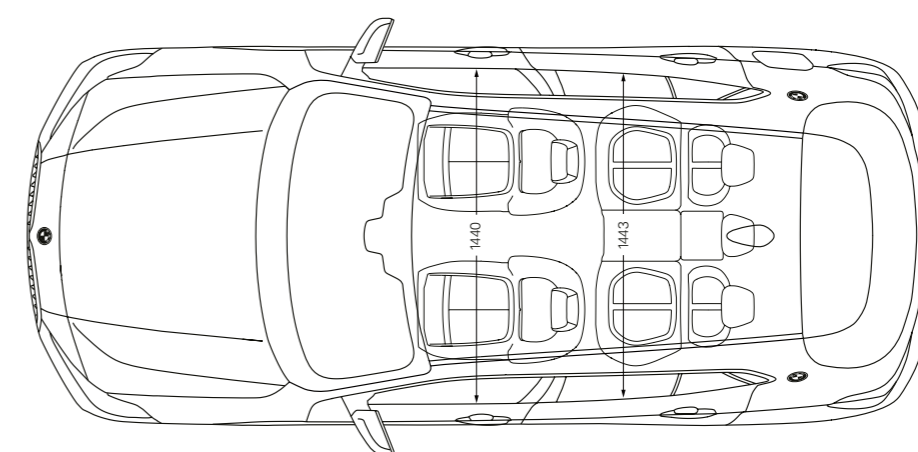
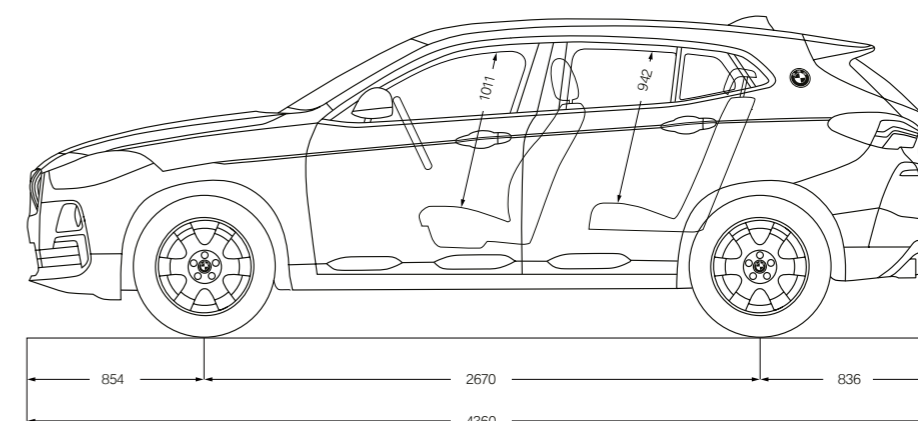
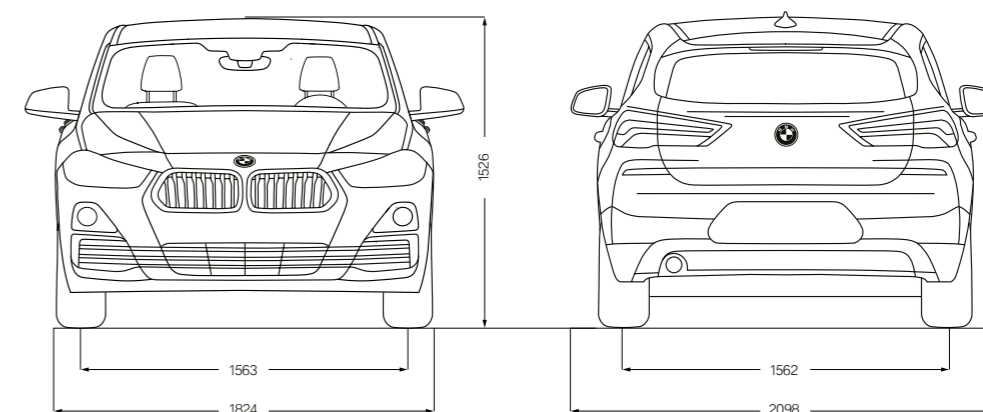

<sup>1</sup> The figures quoted are based on a 90% full tank and a driver weight of 75kg. The unladen weight applies to vehicles with standard equipment. Optional equipment may increase the actual vehicle mass.

<sup>2</sup> The actual total weight of the trailer must not exceed the maximum permitted trailer load, taking into account the maximum tow bar download.

<sup>3</sup> BMW recommends the use of RON 95 super unleaded petrol. Unleaded RON 91 and higher with a maximum ethanol content of 10% (E10) may also be used. Performance and fuel consumption data apply to vehicles using RON 98 fuel.

<sup>4</sup> The stated fuel consumption and CO<sub>2</sub> data were determined in accordance with the applicable type approval requirements and measurement processes as defined by European Regulation (EC) 715/2007. Data refer to a vehicle with base-level equipment in Germany, and the ranges account for differences according to the selected wheel and tyre size. The figures for vehicles marked (\*) have already been determined on the basis of the new WLTP legislation and have been converted back into NEDC figures for comparability. For these vehicles, values other than those specified here may apply for the assessment of taxes and other vehicle-related charges that are (also) based on CO<sub>2</sub> emissions.

**BMW X2 xDrive20d with M Sport X package:**

BMW TwinPower Turbo four-cylinder diesel engine, 140kW (190hp), 20" M light alloy wheels Double-spoke style 717 M, Galvanic Gold metallic exterior colour, Sport seats in Micro Hexagon Alcantara Anthracite cloth with Yellow accent, Aluminium Hexagon Anthracite interior trim.

The models illustrated in this brochure show the equipment and configuration options (standard and optional) for vehicles produced by BMW AG for the German market. Alterations in standard and optional equipment and the configurations available for the different models, as described in this brochure, may occur after 02/09/2017, the date when this brochure went to press, or according to the specific requirements of other markets. Your local BMW Partner is available to provide further details. Subject to change in design and equipment.

© BMW AG, Munich, Germany. Not to be reproduced wholly or in part without prior written permission of BMW AG, Munich.

411 002 347 20 2 2017 BM. Printed in Germany 2018.

